

BROEN-LAB

Drejervaenget 2, 5610 Assens, Denmark

Phone: +45 6376 6376

E-mail: lab@broen-lab.com

Web : broen-lab.com













FITTINGS FOR NON-BURNING 2.0 GASES AND VACUUM

BASIC range

99B0060 Rev. 3 - 07.03.2024

TABLE OF CONTENTS

BROEN-LAB UniFlex™					<i>Page 3</i>
Configuration overview					<i>Page 4</i>
Technical information					<i>Page 5</i>
					
Bench mounted fitting	Suspended fitting with 90° valves	Suspended fitting with 45° valves	Wall mounted double fitting with 90° valves	Wall mounted double fitting with straight valves	
<i>Page 6</i>	<i>Page 7</i>	<i>Page 8</i>	<i>Page 9</i>	<i>Page 10</i>	
					
Wall mounted fitting with 90° valves for exposed piping	Wall mounted fitting with straight valves for exposed piping	Bench og wall mounted fitting with 90° valves and lead-in	Bench og wall mounted fitting with 45° valves and lead-in	Suspended or wall mounted staight fitting with lead-in	
<i>Page 11</i>	<i>Page 12</i>	<i>Page 13</i>	<i>Page 14</i>	<i>Page 15</i>	
BROEN-LAB UniFlex™ hoses for technical gases					<i>Page 16</i>
Headworks					<i>Page 18</i>
Accessories					<i>Page 20</i>
Ordering information					<i>Page 21</i>

BROEN-LAB UNIFLEX™

THIS IS BROEN-LAB UNIFLEX™

BROEN-LAB UniFlex™ line offers a very high quality and durability combined with the complete program, which adds up to low LCC (Life Cycle Costs).

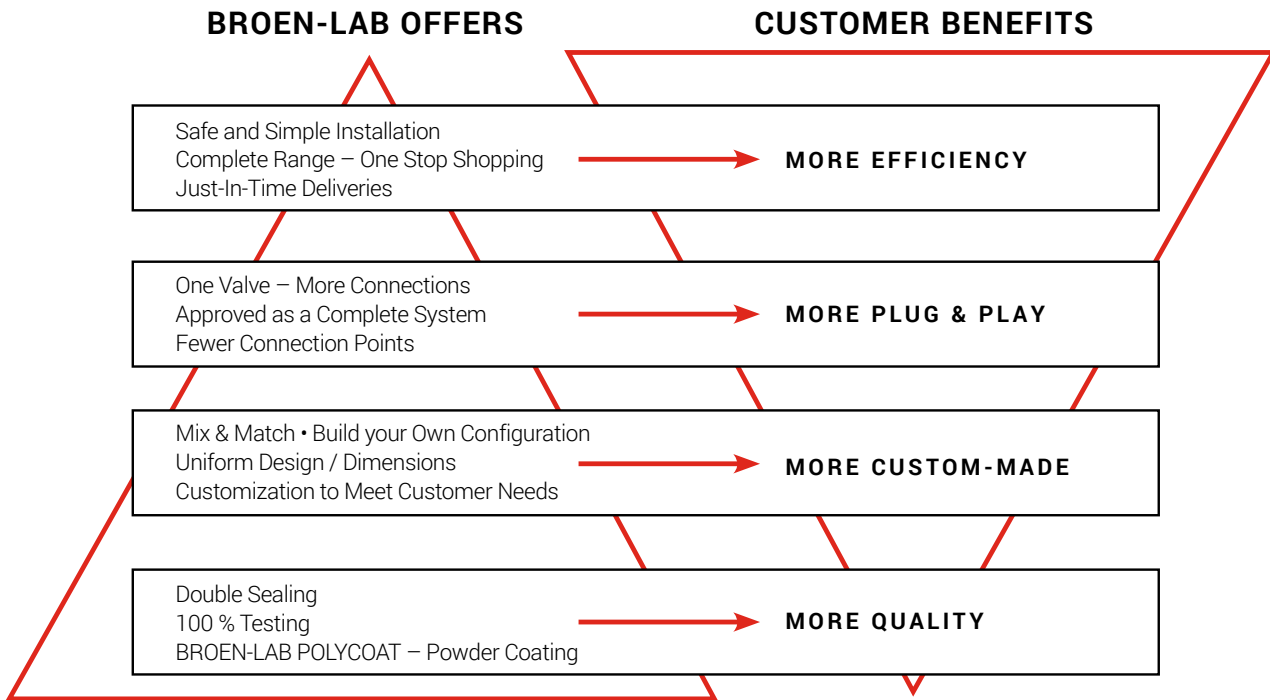

BROEN-LAB UniFlex™ fittings for non-burning 2.0 gases/vacuum are designed for laboratory use. The operation and the configuration of the fittings are highly adapted to the requirements of a modern laboratory. The fittings are surface treated with BROEN-LAB POLYCOAT powder coating, which is highly resistant to most chemicals, UV fading and heat (for more information please refer to "BROEN-LAB POLYCOAT" brochure).

All BROEN-LAB UniFlex™ fittings are delivered with a polypropylene handle with media indication according to EN13792. As an option it is possible to get fittings with disability-friendly handle for easier operation.

As standard BROEN-LAB UniFlex™ fittings are delivered with a fixed polypropylene nozzle (can be unscrewed by hand if needed) or a quick release coupling (hexagon coded) for easy and immediate connection and safe disconnection. As an option a removable polypropylene nozzle can be used.

THIS IS BROEN-LAB UNIFLEX™

BROEN-LAB UniFlex™ is a unique and patented connection, which allows customers to choose from various connection methods, such as hoses, Cu, PEX or Stainless Steel pipes, without changing the valve itself. It provides unique flexibility, not only for the installer, but also for the end-user. Due to the flexibility of the system, the quick installation and savings on fittings, this system offers lower TIC (Total Installed Costs).

CONFIGURATION OVERVIEW

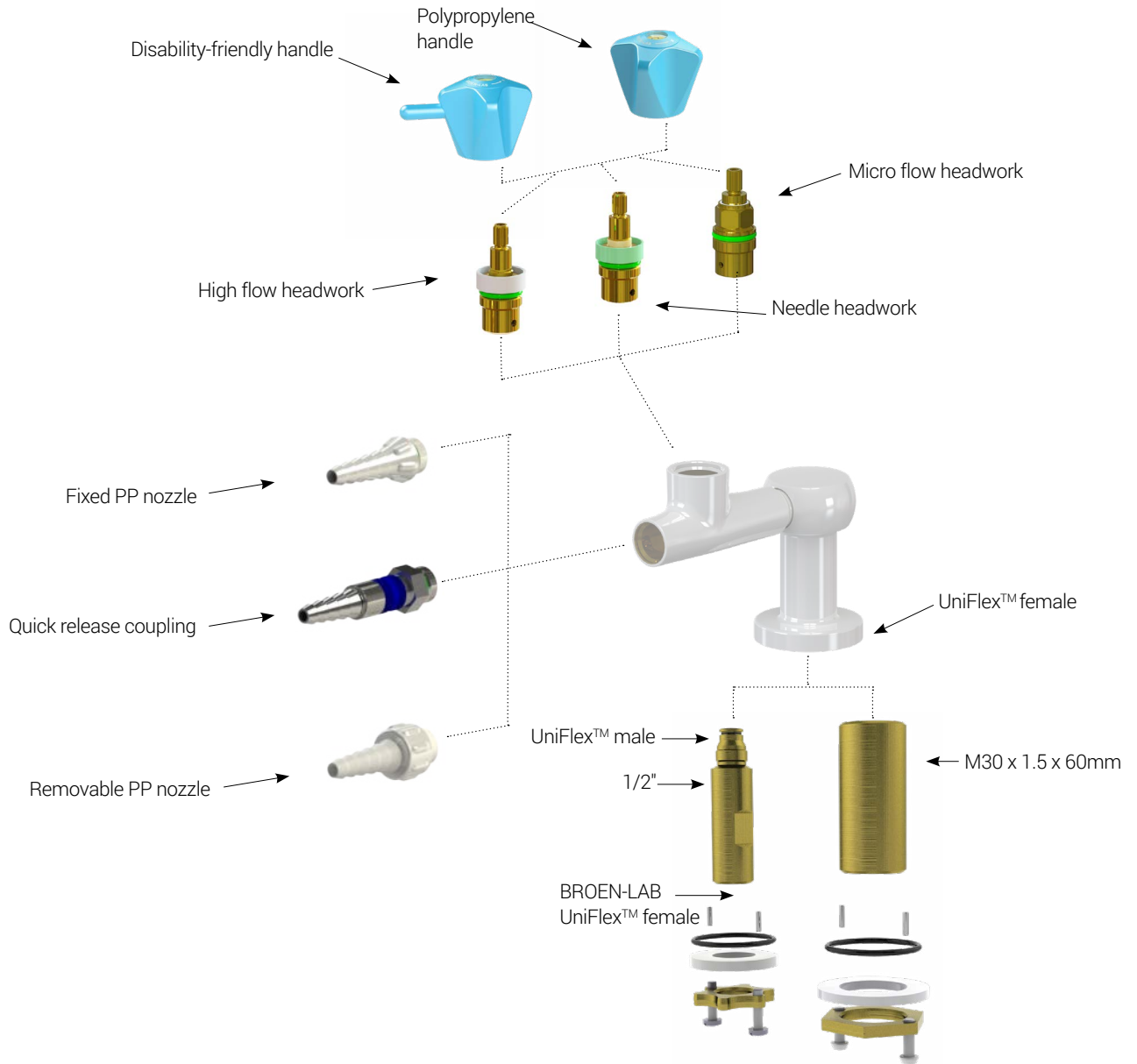

Optional hoses to add

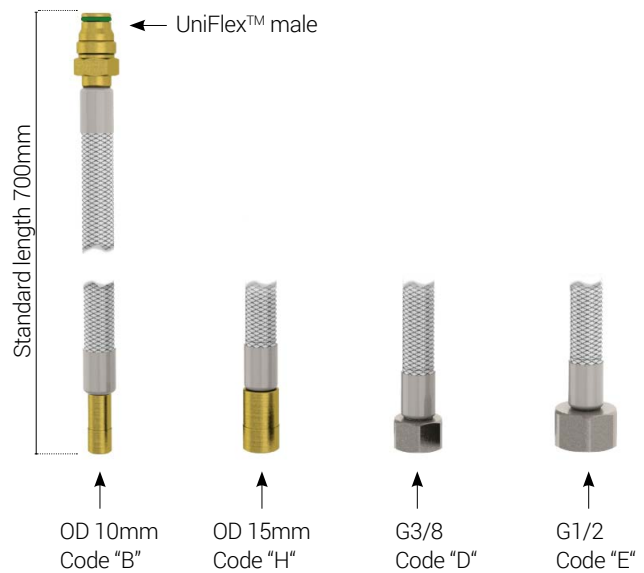

TECHNICAL INFORMATION

WHAT IS NON-BURNING 2.0 GAS?

Non-burning 2.0 gases are typical industrial and technical gases that are 99% clean.

BROEN-LAB UniFlex™ fittings for non-burning gases can be used for non-toxic, non-corrosive, non-burning 2.0 gases, such as Compressed Air, Nitrogen, Carbon Dioxide, Argon, etc.

These gases are typically commercially manufactured and sold to be used in applications within:

- laboratory and instrumentation
- chemical industry
- cutting and welding
- food processing, etc.

WHAT IS VACUUM?

Vacuum is a volume of space that is essentially empty of matter, such that its gaseous pressure is much less than atmospheric pressure.

Vacuum is usually measured by its absolute pressure and is divided into several types (according to EN 13792):

- Low Vacuum: 1000 to 1mbar
- Fine Vacuum : 1 to 10⁻³ mbar
- High Vacuum: 10⁻³ to 10⁻⁷ mbar

Laboratory applications usually require use of suction. Suction is a flow of media into a partial vacuum, or region with low pressure. It is being used to clear surfaces, containers or tubing of residues or other materials.

OUR HEADWORKS

BROEN-LAB UniFlex™ fittings for non-burning 2.0 gases can be delivered with 4 different types of headworks depending on the requirements set by applications with regards to regulation of media flow.

Needle headwork



High flow headwork



Micro flow headwork



1/4-turn headwork



As standard all BROEN-LAB UniFlex™ fittings for non-burning 2.0 gases are delivered with a needle headwork that allows fine regulation of media flow and the valve is fully opened after 3 x 360° rotations of a handle.

As standard all BROEN-LAB UniFlex™ fittings for vacuum are delivered with a high flow headwork. If there is a need for high flow of other media than vacuum, or a valve should function as a shut-off, then it is possible to get a fitting with a high flow headwork for 2.0 non-burning gases.

In cases where media flow (2.0 non-burning gases) is close to zero and when a microscopic flow rate is required then it is an option to choose a micro flow headwork, which provides a very fine regulation of media flow.

For more information about BROEN-LAB headworks and technical details please refer to pages 18-19 in this catalogue.

BENCH MOUNTED FITTING

Specifications

Handle: Polypropylene, media indication according to EN13792
 Hose nozzle: Polypropylene, fixed (can be unscrewed by hand, thread: male G3/8")

Non-burning 2.0 gases

Headwork: Needle
 Opening/closing function:
 3 x 360°
 Max. working pressure:
 16 bar / 232 psi

Vacuum / High Flow

Headwork: High flow
 Opening/closing function:
 1.5 x 360°
 Working pressure:
 -1 bar to 16 bar /
 -14.5 psi to 232 psi

Allowable test pressure after installation:
 1.5 x max working pressure without function of the valve

Materials with media contact

Metals: Brass
 Plastics: PVDF, PP
 Sealing: FKM
 Lubricant: Perfluoropolyether based

Ordering information

For standard configuration please refer to the item numbers below.

Other options:

- different media
- removable polypropylene hose nozzle with union nut
- disability-friendly handle (single valve only)
- micro flow headwork (for 2.0 non-burning gases)
- high flow headwork (for 2.0 non-burning gases)
- alternative hose inlet connection / without a hose
- other inlet options (type, length)

With fixed nozzle

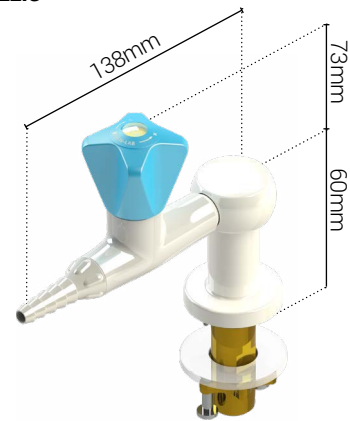

With quick release coupling

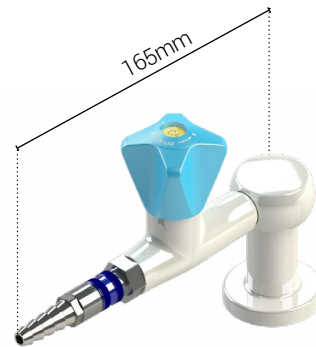

Configuration options

2.0 Gases: Choose outlet connection, number of valves and media type:



	1-way valve	2-way 90° valve	2-way 180° valve	4-way valve
Fixed nozzle	2532 001 10 XX-YY	2532 014 10 XX-YY	2532 008 10 XX-YY	2532 020 10 XX-YY
Quick release nozzle	2532 003 10 XX-YY	2532 016 10 XX-YY	2532 010 10 XX-YY	2532 122 10 XX-YY

Replace **XX** with one of these media types:



21 • Compressed air



23 • Nitrogen



24 • Carbon dioxide



25 • Argon



26 • Helium

Vacuum: Choose outlet connection and number of valves,;

	1-way valve	2-way 90° valve	2-way 180° valve	4-way valve
Fixed nozzle	2532 002 10 XX-YY	2532 015 10 XX-YY	2532 009 10 XX-YY	2532 021 10 XX-YY
Quick release nozzle	2532 108 10 XX-YY	2532 124 10 XX-YY	2532 107 10 XX-YY	2532 123 10 XX-YY



28 • Low vacuum (1000 to 1 mbar)

SUSPENDED FITTING WITH 90° VALVES

Specifications

Handle: Polypropylene, media indication according to EN13792
 Hose nozzle: Polypropylene, fixed (can be unscrewed by hand, thread: male G3/8")

Non-burning 2.0 gases

Headwork: Needle
 Opening/closing function:
 3 x 360°
 Max. working pressure:
 16 bar / 232 psi

Vacuum / High Flow

Headwork: High flow
 Opening/closing function:
 1.5 x 360°
 Working pressure:
 -1 bar to 16 bar /
 -14.5 psi to 232 psi

Allowable test pressure after installation:
 1.5 x max working pressure without function of the valve

Materials with media contact

Metals: Brass
 Plastics: PVDF, PP
 Sealing: FKM
 Lubricant: Perfluoropolyether based

Ordering information

For standard configuration please refer to the item numbers below.

Other options:

- different media
- removable hose nozzle with union nut
- disability-friendly handle (single valve only)
- micro flow headwork (for 2.0 non-burning gases)
- high flow headwork (for 2.0 non-burning gases)
- alternative hose inlet connection / without a hose
- other inlet options (type, length)

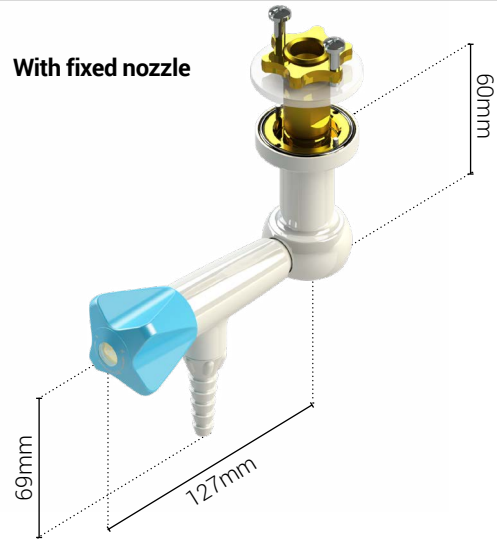

With quick release coupling

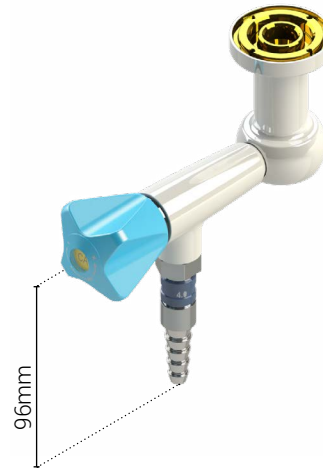

Configuration options

2.0 Gases: Choose outlet connection, number of valves and media type:



	1-way valve	2-way 90° valve	2-way 180° valve	4-way valve
Fixed nozzle	2530 075 10XX-YY	2530 080 10XX-YY	2530 042 10XX-YY	2530 203 10XX-YY
Quick release nozzle	2530 205 10XX-YY	2530 207 10XX-YY	2530 209 10XX-YY	2530 211 10XX-YY

Replace **XX** with one of these media types:



Vacuum: Choose outlet connection and number of valves::

	1-way valve	2-way 90° valve	2-way 180° valve	4-way valve
Fixed nozzle	2530 074 10XX-YY	2530 082 10XX-YY	2530 052 10XX-YY	2530 204 10XX-YY
Quick release nozzle	2530 206 10XX-YY	2530 208 10XX-YY	2530 210 10XX-YY	2530 212 10XX-YY



SUSPENDED FITTING WITH 45° VALVES

Specifications

Handle: Polypropylene, media indication according to EN13792
 Hose nozzle: Polypropylene, fixed (can be unscrewed by hand, thread: male G3/8")

Non-burning 2.0 gases

Headwork: Needle
 Opening/closing function:
 3 x 360°
 Max. working pressure:
 16 bar / 232 psi

Vacuum / High Flow

Headwork: High flow
 Opening/closing function:
 1.5 x 360°
 Working pressure:
 -1 bar to 16 bar /
 -14.5 psi to 232 psi

Allowable test pressure after installation:
 1.5 x max working pressure without function of the valve

Materials with media contact

Metals: Brass
 Plastics: PVDF, PP
 Sealing: FKM
 Lubricant: Perfluoropolyether based

Ordering information

For standard configuration please refer to the item numbers below.

Other options:

- different media
- removable hose nozzle with union nut
- micro flow headwork (for 2.0 non-burning gases)
- high flow headwork (for 2.0 non-burning gases)
- alternative hose inlet connection / without a hose
- other inlet options (type, length)

With fixed nozzle

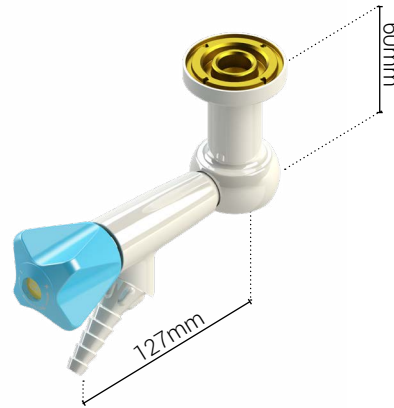

With quick release coupling



Configuration options

2.0 Gases: Choose outlet connection, number of valves and media type:



	1-way valve	2-way 90° valve	2-way 180° valve	4-way valve
Fixed nozzle	2530 189 10XX-08	2530 191 10XX-08	2530 065 10XX-08	2530 193 10XX-08
Quick release nozzle	2530 195 10XX-08	2530 197 10XX-08	2530 199 10XX-08	2530 201 10XX-08

Replace **XX** with one of these media types:



21 • Compressed air



23 • Nitrogen



24 • Carbon dioxide



25 • Argon



26 • Helium

Vacuum: Choose outlet connection and number of valves:

	1-way valve	2-way 90° valve	2-way 180° valve	4-way valve
Fixed nozzle	2530 190 10XX-08	2530 192 10XX-08	2530 062 10XX-08	2530 194 10XX-08
Quick release nozzle	2530 196 10XX-08	2530 198 10XX-08	2530 200 10XX-08	2530 202 10XX-08



28 • Low vacuum (1000 to 1 mbar)

WALL MOUNTED DOUBLE FITTING WITH 90° VALVES

Specifications

Handle: Polypropylene, media indication according to EN13792
 Hose nozzle: Polypropylene, fixed (can be unscrewed by hand, thread: male G3/8")

Non-burning 2.0 Gases

Headwork: Needle
 Opening/closing function:
 3 x 360°
 Max. working pressure:
 16 bar / 232 psi

Vacuum / High Flow

Headwork: High flow
 Opening/closing function:
 1.5 x 360°
 Working pressure:
 -1 bar to 16 bar /
 -14.5 psi to 232 psi

Allowable test pressure after installation:
 1.5 x max working pressure without function of the valve

Materials with media contact

Metals: Brass
 Plastics: PVDF, PP
 Sealing: FKM
 Lubricant: Perfluoropolyether based

Ordering information

For standard configuration please refer to the item numbers below.

Other options:

- different media
- removable hose nozzle with union nut
- disability-friendly handle
- micro flow headwork (for technical gases)
- high flow headwork (for technical gases)
- alternative hose inlet connection / without a hose
- other inlet options (type, length)

With fixed nozzle

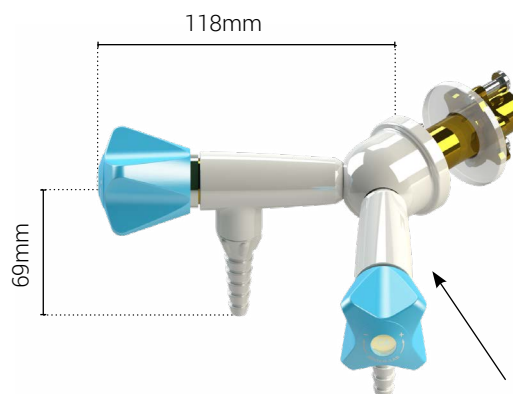

With quick release coupling

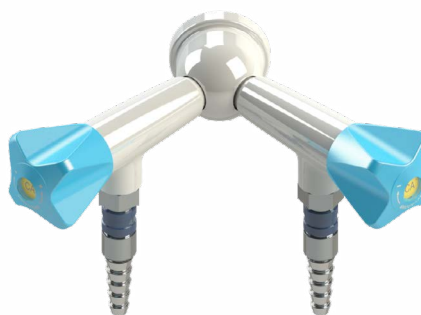

Configuration options

2.0 Gases: Choose outlet connection and media type:

	2-way 90° valve
Fixed nozzle	2530 185 10 XX -08
Quick release nozzle	2530 187 10 XX -08

Replace **XX** with one of these media types:



Vacuum: Choose outlet connection:

	2-way 90° valve
Fixed nozzle	2530 186 1028-08
Quick release nozzle	2530 188 1028-08

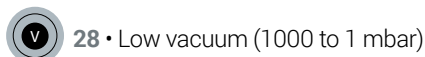

WALL MOUNTED DOUBLE FITTING WITH STRAIGHT VALVES

Specifications

Handle: Polypropylene, media indication according to EN13792
 Hose nozzle: Polypropylene, fixed (can be unscrewed by hand, thread: male G3/8")

Non-burning 2.0 Gases

Headwork: Needle
 Opening/closing function:
 3 x 360°
 Max. working pressure:
 16 bar / 232 psi

Vacuum / High Flow

Headwork: High flow
 Opening/closing function:
 1.5 x 360°
 Working pressure:
 -1 bar to 16 bar /
 -14.5 psi to 232 psi

Allowable test pressure after installation:
 1.5 x max working pressure without function of the valve

Materials with media contact

Metals: Brass
 Plastics: PVDF, PP
 Sealing: FKM
 Lubricant: Perfluoropolyether based

Ordering information

For standard configuration please refer to the item numbers below.

Other options:

- different media
- removable hose nozzle with union nut
- micro flow headwork (for 2.0 non-burning gases)
- high flow headwork (for 2.0 non-burning gases)
- alternative hose inlet connection / without a hose
- other inlet options (type, length)

With fixed nozzle

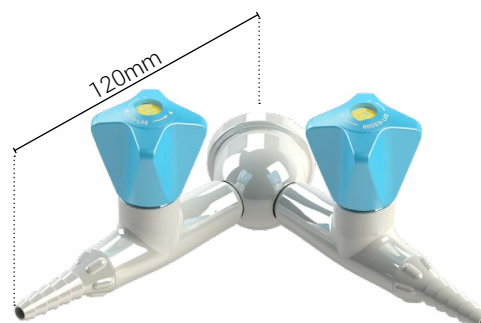

With quick release coupling

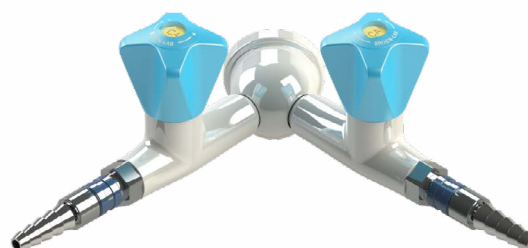

Configuration options

2.0 Gases: Choose outlet connection and media type:

	2-way 90° valve
Fixed nozzle	2532 050 10 XX-YY
Quick release nozzle	2532 120 10 XX-YY

Replace **XX** with one of these media types:



21 • Compressed air



23 • Nitrogen



24 • Carbon dioxide



25 • Argon



26 • Helium

Vacuum: Choose outlet connection:

	2-way 90° valve
Fixed nozzle	2532 051 1028- YY
Quick release nozzle	2532 121 1028- YY



28 • Low vacuum (1000 to 1 mbar)

WALL MOUNTED FITTING WITH 90° VALVES FOR EXPOSED PIPING

Specifications

Handle: Polypropylene, media indication according to EN13792
 Hose nozzle: Polypropylene, fixed (can be unscrewed by hand, thread: male G3/8")

Non-burning 2.0 gases

Headwork: Needle
 Opening/closing function: 3 x 360°
 Max. working pressure: 16 bar / 232 psi

Vacuum / High Flow

Headwork: High flow
 Opening/closing function: 1.5 x 360°
 Working pressure: -1 bar to 16 bar / -14.5 psi to 232 psi

Allowable test pressure after installation:
 1.5 x max working pressure without function of the valve

Materials with media contact

Metals: Brass
 Plastics: PVDF, PP
 Sealing: FKM
 Lubricant: Perfluoropolyether based

Ordering information

For standard configuration please refer to the item numbers below.

Other options:

- different media
- removable hose nozzle with union nut
- disability-friendly handle
- micro flow headwork (for 2.0 non-burning gases)
- high flow headwork (for 2.0 non-burning gases)
- wall flange socket for built-in installation

With fixed nozzle

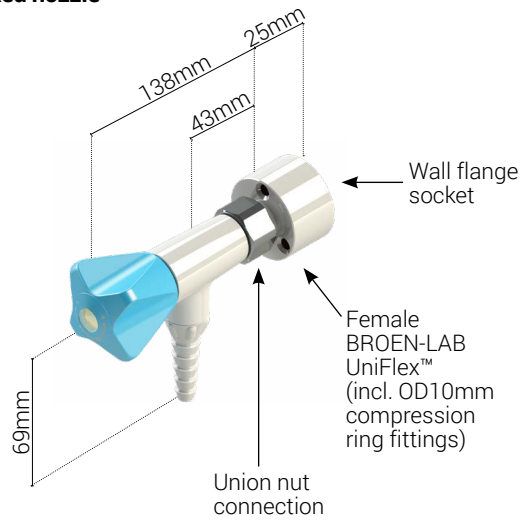

With quick release coupling

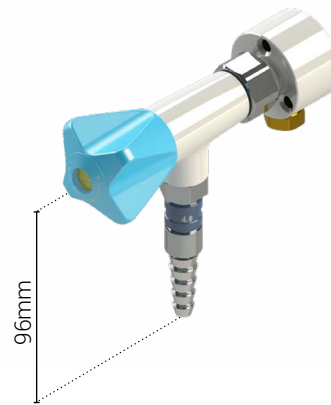

Configuration options

2.0 Gases: Choose outlet connection and media type:

	1-way valve
Fixed nozzle	2530 177 10XX-T
Quick release nozzle	2530 179 10XX-T

Replace **XX** with one of these media types:



Vacuum: Choose outlet connection:

	1-way valve
Fixed nozzle	2530 178 1028-T
Quick release nozzle	2530 180 1028-T

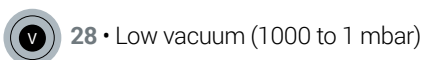

WALL MOUNTED FITTING WITH STRAIGHT VALVES FOR EXPOSED PIPING

Specifications

Handle: Polypropylene, media indication according to EN13792
 Hose nozzle: Polypropylene, fixed (can be unscrewed by hand, thread: male G3/8")

Non-burning 2.0 gases

Headwork: Needle
 Opening/closing function:
 3 x 360°
 Max. working pressure:
 16 bar / 232 psi

Vacuum / High Flow

Headwork: High flow
 Opening/closing function:
 1.5 x 360°
 Working pressure:
 -1 bar to 16 bar /
 -14.5 psi to 232 psi

Allowable test pressure after installation:
 1.5 x max working pressure without function of the valve

Materials with media contact

Metals: Brass
 Plastics: PVDF, PP
 Sealing: FKM
 Lubricant: Perfluoropolyether based

Ordering information

For standard configuration please refer to the item numbers below.

Other options:

- different media
- removable hose nozzle with union nut
- disability-friendly handle
- micro flow headwork (for 2.0 non-burning gases)
- high flow headwork (for 2.0 non-burning gases)
- wall flange socket for built-in installation

With fixed nozzle

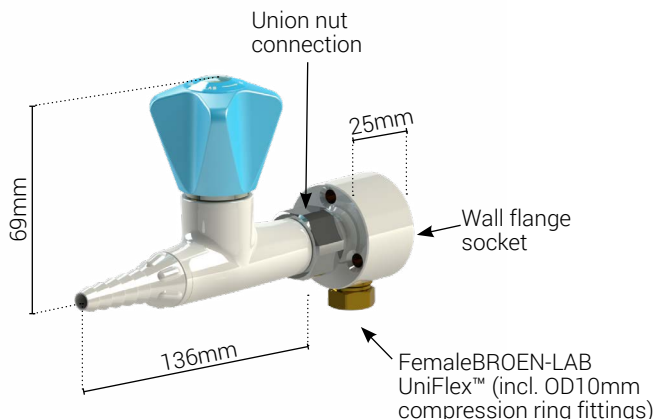

With quick release coupling

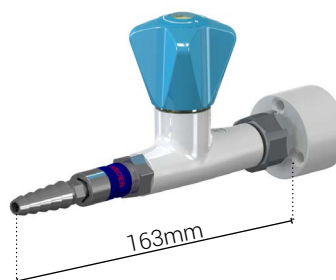

Configuration options

2.0 Gases: Choose outlet connection and media type:

	1-way valve
Fixed nozzle	2532 110 10 XX -T
Quick release nozzle	2532 118 10 XX -T

Replace **XX** with one of these media types:



Vacuum: Choose outlet connection:

	1-way valve
Fixed nozzle	2532 117 1028-T
Quick release nozzle	2532 119 1028-T

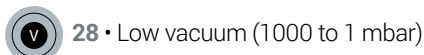

WALL MOUNTED 90° FITTING WITH LEAD-IN

Specifications

Handle: Polypropylene, media indication according to EN13792
 Hose nozzle: Polypropylene, fixed (can be unscrewed by hand, thread: male G3/8")

Non-burning 2.0 Gases

Headwork: Needle
 Opening/closing function:
 3 x 360°
 Max. working pressure:
 16 bar / 232 psi

Vacuum / High Flow

Headwork: High flow
 Opening/closing function:
 1.5 x 360°
 Working pressure:
 -1 bar to 16 bar /
 -14.5 psi to 232 psi

Allowable test pressure after installation:
 1.5 x max working pressure without function of the valve

Materials with media contact

Metals: Brass
 Plastics: PVDF, PP
 Sealing: FKM
 Lubricant: Perfluoropolyether based

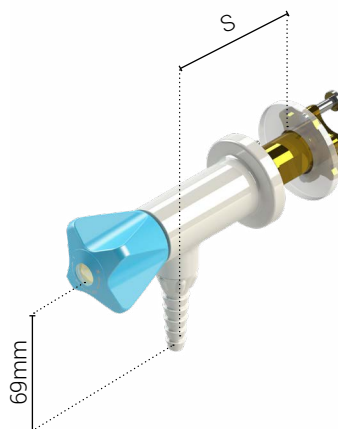

Ordering information

For standard configuration please refer to the item numbers below.

Other options:

- different media
- removable hose nozzle with union nut
- disability-friendly handle
- micro flow headwork (for 2.0 non-burning gases)
- high flow headwork (for 2.0 non-burning gases)
- alternative hose inlet connection / without a hose
- other inlet options (type, length)

Configuration options

2.0 Gases: Choose outlet connection, length of valve and media type:

	S=50	S=75
Fixed nozzle	2530 311 10XX-YY	2530 305 10XX-YY
Quick release nozzle	2530 313 10XX-YY	2530 308 10XX-YY

Replace **XX** with one of these media types:



21 • Compressed air



23 • Nitrogen



24 • Carbon dioxide



25 • Argon



26 • Helium

Vacuum: Choose outlet connection and length of valve:

	S=50	S=75
Fixed nozzle	2530 312 1028-YY	2530 306 1028-YY
Quick release nozzle	2530 314 1028-YY	2530 309 1028-YY



28 • Low vacuum (1000 to 1 mbar)

BENCH OR WALL MOUNTED 45° FITTING WITH LEAD-IN

Specifications

Handle: Polypropylene, media indication according to EN13792
 Hose nozzle: Polypropylene, fixed (can be unscrewed by hand, thread: male G3/8")

Non-burning 2.0 Gases

Headwork: Needle
 Opening/closing function:
 3 x 360°
 Max. working pressure:
 16 bar / 232 psi

Vacuum / High Flow

Headwork: High flow
 Opening/closing function:
 1.5 x 360°
 Working pressure:
 -1 bar to 16 bar /
 -14.5 psi to 232 psi

Allowable test pressure after installation:
 1.5 x max working pressure without function of the valve

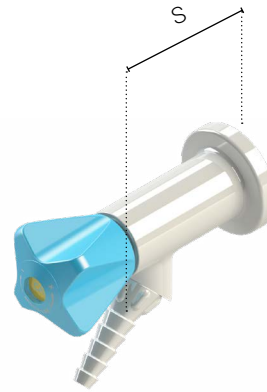

Materials with media contact

Metals: Brass
 Plastics: PVDF, PP
 Sealing: FKM
 Lubricant: Perfluoropolyether based

Ordering information

For standard configuration please refer to the item numbers below.

Other options:

- different media
- removable hose nozzle with union nut
- disability-friendly handle
- micro flow headwork (for 2.0 non-burning gases)
- high flow headwork (for 2.0 non-burning gases)
- alternative hose inlet connection / without a hose
- other inlet options (type, length)

Configuration options

2.0 Gases: Choose outlet connection, length of valve and media type:

	S=50	S=75
Fixed nozzle	2530 361 10 XX-YY	2530 357 10 XX-YY
Quick release nozzle	2530 363 10 XX-YY	2530 359 10 XX-YY

Replace **XX** with one of these media types:



21 • Compressed air



23 • Nitrogen



24 • Carbon dioxide



25 • Argon



26 • Helium

Vacuum: Choose outlet connection and length of valve:

	S=50	S=75
Fixed nozzle	2530 362 1028- YY	2530 358 10 XX-YY
Quick release nozzle	2530 364 1028- YY	2530 360 10 XX-YY



28 • Low vacuum (1000 to 1 mbar)

SUSPENDED OR WALL MOUNTED STRAIGHT FITTING WITH LEAD-IN

Specifications

Handle: Polypropylene, media indication according to EN13792
 Hose nozzle: Polypropylene, fixed (can be unscrewed by hand, thread: male G3/8")

Non-burning 2.0 Gases

Headwork: Needle
 Opening/closing function: 3 x 360°
 Max. working pressure: 16 bar / 232 psi

Vacuum / High Flow

Headwork: High flow
 Opening/closing function: 1.5 x 360°
 Working pressure: -1 bar to 16 bar / -14.5 psi to 232 psi

Allowable test pressure after installation:
 1.5 x max working pressure without function of the valve

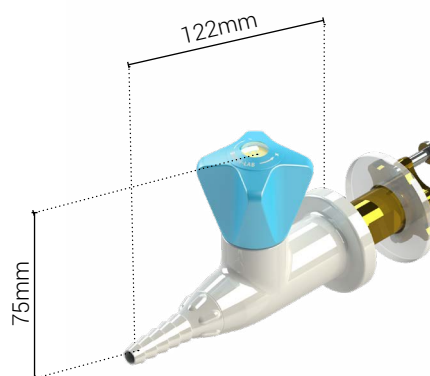

Materials with media contact

Metals: Brass
 Plastics: PVDF, PP
 Sealing: FKM
 Lubricant: Perfluoropolyether based

Ordering information

For standard configuration please refer to the item numbers below.

Other options:

- different media
- removable hose nozzle with union nut
- micro flow headwork (for 2.0 non-burning gases)
- high flow headwork (for 2.0 non-burning gases)
- alternative hose inlet connection / without a hose
- other inlet options (type, length)

Configuration options

2.0 Gases: Choose outlet connection and media type:

	1-way valve
Fixed nozzle	2532 192 10 XX-YY
Quick release nozzle	2532 186 10 XX-YY

Replace **XX** with one of these media types:



Vacuum: Choose outlet connection:

	1-way valve
Fixed nozzle	2532 178 1028- YY
Quick release nozzle	2532 201 1028- YY

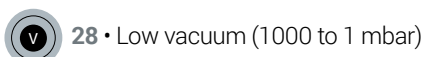

BROEN-LAB UNIFLEX™ HOSES FOR NON-BURNING 2.0 GASES AND VACUUM

BROEN-LAB UniFlex™ flexible hoses



BROEN-LAB LAB offers BROEN-LAB UniFlex™ hoses as an easy way to make the installation in the laboratory where safety and efficiency are required. BROEN-LAB UniFlex™ hoses are the ideal solution where there is a higher requirement for flexibility. Installation with flexible hoses saves you time and labor - in other words reduced installation costs.

BROEN-LAB UniFlex™ hoses for non-burning 2.0 gases and vacuum are manufactured of soft cross-linked polyethylene (SPX). From the outside the hose is secured by a Stainless Steel braiding that ensures long service life and durability.

A wide range of fittings and lengths is available for BROEN-LAB UniFlex™ hoses enables customers to choose the perfect hose for their application. Please request document No. 99G0005 for complete range of BROEN-LAB UniFlex™ hoses and technical specifications.

If you still prefer a standard way of installation with Cu, Stainless Steel, or PEX-pipes, BROEN-LAB LAB offers a wide range of connection fittings and adaptors for pipes of different dimensions. Please request document No. 99G0004 for a complete range of BROEN-LAB UniFlex™ compression ring fittings.

BROEN-LAB UniFlex™ connection fittings and adaptors for CU, Stainless Steel and PEX pipes

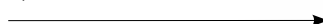

The total design of the system must be taken into consideration when selecting the type of BROEN-LAB UniFlex™ flexible hose or pipe for specific media. Only then products will provide safe, trouble-free operation.















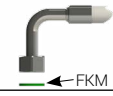

Please always check local requirements/regulations regarding installation and maintenance of hoses/flexible pipes!

A very high quality of materials applied for production of hoses and Stainless Steel flexible pipes, which are supplied by BROEN-LAB, and a long-time experience in making installations worldwide, combined with optimal installation conditions, may assure a lifetime for a hose to be more than 10 years. Expected lifetime can only be achieved under normal use and proper installation methods, which are described in technical specifications, i.e. max. working pressure, max. temperature, physical installation methods and other. Any nonconformity to specifications decreases the lifetime of a hose/flexible pipe.



Hose	SPX
Factors*	93T
Inner hose material with media contact	SPX
Outer hose material / braiding	Stainless Steel AISI 304
Sealing material	FKM
Inside diameter	8.2 mm
Outside diameter	12 mm
Max. working pressure	16 bar
Max. working temperature	90°C
Min. bending radius (inner)	40 mm
Leakage rate	-
UV resistance	++
Range of connections	+++

93T - BROEN-LAB UNIFLEX™ HOSES FOR NON-BURNING 2.0 GASES/VACUUM

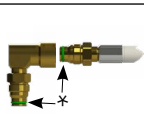
INLET CONNECTIONS 93 T **XX** XX XXXX

61	3/8" NPT swivel connection	
36	Male G1/4" fixed connection	
32	Male G3/8" fixed connection	
31	Male G1/2" fixed connection	
34	3/8" NPT fixed connection	
35	3/8" NPT Swivel connection	
46	90° female G3/8" Union nut connection	
41	Female G3/8" union nut connection	
40	Female G1/2" union nut connection	
45	90° female G1/2" union nut connection	
09	OD3/8" connection for compression fittings	
10	OD10 mm connection for compression fittings	
12	OD12 mm connection for compression fittings	
13	OD1/2" connection for compression fittings	
15	OD15 mm connection for compression fittings	
65	OD15 mm connection for press fittings	
20	Straight BROEN-LAB UniFlex™ connection with FKM O-ring	
25	45° BROEN-LAB UniFlex™ connection with FKM O-ring	
30	90° BROEN-LAB UniFlex™ connection with FKM O-ring	

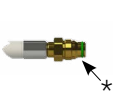
OUTLET CONNECTIONS 93 T XX **XX** XXXX

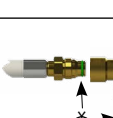
20	Straight BROEN-LAB UniFlex™ connection with FKM O-ring	
25	45° BROEN-LAB UniFlex™ connection with FKM O-ring	
30	90° BROEN-LAB UniFlex™ connection with FKM O-ring	

*All O-rings are lubricated with perfluoropolyether based lubricant

SPECIFICATIONS

Inner hose material: SPX (soft pex)
 Braiding: Stainless Steel with one green stripe
 Materials with media contact: PEX, brass, FKM and perfluoropolyether based lubricant
 Inside diameter: 8.2 mm
 Outside diameter: 12 mm
 Max. working pressure: 16 bar
 Max. working temperature: 90°C
 Bending radius (inner): ≥ 40 mm
 Min. length with connections: 160 mm

LENGTH 93 T XX XX **XXXX**

SPX hose with braiding in Stainless Steel



Marking for technical gas with Part no. and Media indication

HOSE LENGTHS

Definition of length (L)

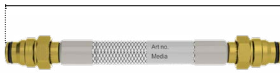

Definition of length (L)

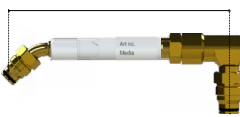

If 45° and 90° elbows occur on the same hose, it will as default be mounted in U-form

**Standard lengths of hoses (L):

- 0500** = 500 mm
- 0700** = 700 mm
- 1000** = 1000 mm
- 1200** = 1200 mm
- 1500** = 1500 mm
- 2000** = 2000 mm
- 2500** = 2500 mm
- 3000** = 3000 mm

Length tolerance of hoses:
 L = ≤400 mm (-0, +10 mm)
 L = 401 mm to 1000 mm (-0, +20 mm)
 L = >1000 mm (-0, +30 mm)

** Other lengths are available on request

EXAMPLE OF HOSE CONFIGURATION

1200 mm hose with OD 12 mm inlet connection and straight UniFlex™ outlet connection



93T12201200

TECHNICAL INFORMATION

NEEDLE HEADWORK

Specifications

BROEN-LAB UniFlex™ fittings for non-burning 2.0 gases are as a standard delivered with needle headwork for fine regulation of media flow.

Opening/closing function: 3 x 360° turn

Media: Non-burning 2.0 (99% clean) gases

Max. working pressure: 16 bar / 232 psi

Test pressure: 1.5 x working pressure

Materials with media contact

Metals: Brass

Plastics: PVDF

Sealing: FKM

Lubricant: Perfluoropolyether based

Ordering information

1. Green plastic ring • No. 0255 035-5168

2. Needle headwork • No. 0255 7300

Flow Chart

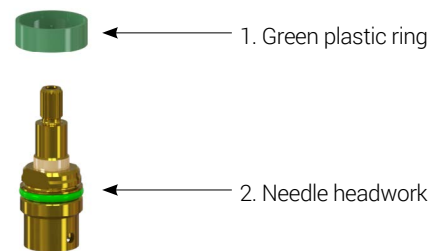
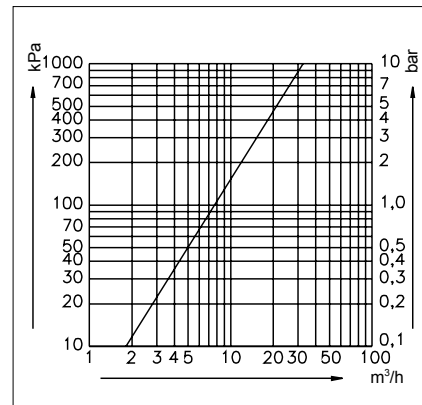

TECHNICAL INFORMATION

HIGH FLOW HEADWORK

Specifications

BROEN-LAB UniFlex™ fittings for vacuum are as a standard delivered with a high flow headwork. This headwork ensures high flow of media and can also be used for other non-burning 2.0 gases.

Opening/closing function: 1.5 x 360° turn

Media: Vacuum and non-burning 2.0 (99% clean) gases

Working pressure: -1 to 16 bar / -14.5 to 232 psi

Test pressure: 1.5 x working pressure

Materials with media contact

Metals: Brass

Plastics: PVDF

Sealing: FKM

Lubricant: Perfluoropolyether based

Ordering information

1. Grey plastic ring • No. 0255 035-2696

2. High flow headwork • No. 0255 6300

Flow Chart

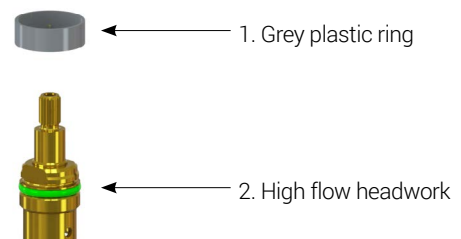
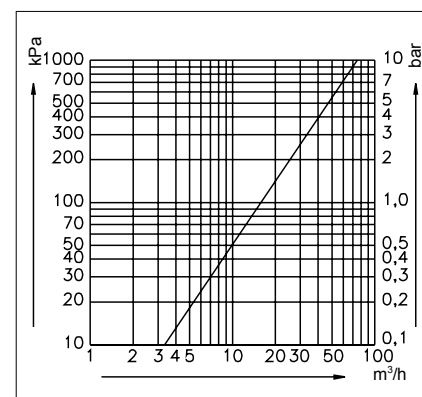

TECHNICAL INFORMATION

MICRO FLOW HEADWORK

Specifications

BROEN-LAB Micro flow headwork ensures very fine regulation of media where flow of gas is close to zero and microscopic flow rates are required.

Opening/closing function: 7.5 x 360° turn

Media: Non-burning 2.0 (99% clean) gases

Max. working pressure: 16 bar / 232 psi

Test pressure: 1.5 x working pressure

Flow Chart

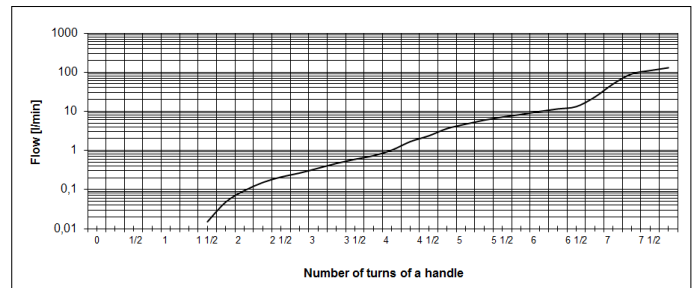

Materials with media contact

Metals: Brass

Plastics: PVDF

Sealing: FKM

Lubricant: Perfluoropolyether based

Ordering information

Micro flow headwork • No. 1915 4400



← Micro flow headwork

TECHNICAL INFORMATION

1/4-TURN HEADWORK

Specifications

BROEN-LAB UniFlex™ fittings for non-burning 2.0 gases and vacuum can also be delivered with a 1/4-turn headwork (also recommended for disability friendly handle)

Opening/closing function: 90° turn

Media: Vacuum and non-burning 2.0 (99% clean) gases

Working pressure: -1 to 8 bar / -14.5 to 116 psi

Test pressure: 1.5 x working pressure

Materials with media contact

Metals: Brass

Sealing: FKM

Lubricant: Perfluoropolyether based

Ordering information

1/4-turn headwork • No. 19174100



← 1/4-turn headwork

ACCESSORIES

Illustration	Description	BROEN-LAB item no.	
	Adaptor for removable polypropylene nozzle 3/8 to G1/2"	2539 048 1021	
	Removable polypropylene nozzle G1/2"	2539 008 1021	
	Fixed polypropylene nozzle 3/8	2539 042 1021	
	Quick release coupling (hexagon coded) Coupling unit Nozzle unit	96C0043 96C0042	
	Mounting set for G1/2" connection Mounting set for M30x1.5 connection	19 141 000 19 190 000	
	G1/2" inlet with female BROEN-LAB UniFlex™ connection (incl. o-ring) L = 30mm L = 60mm L = 90mm	15 504 33T 15 504 12T 15 504 46T	Code -05 Code -14 Code -18
	Threaded inlet pipe M30x1.5 L = 30mm L = 60mm L = 90mm	19 190 03 19 190 02 19 190 04	Code -50 Code -52 Code -54
	Wall flange socket (WFS) (for exposed piping)	02 101 30G	
	Wall flange socket (WFS) (for built-in installation)	02 101 31	
	Cover flange for 02 101 310	14 923 04G	
	Metal handle with media indication according to EN 13792	19 150 140 10XX 19 150 140 10XX	Replace XX/XX with the media on page 23

ORDERING INFORMATION



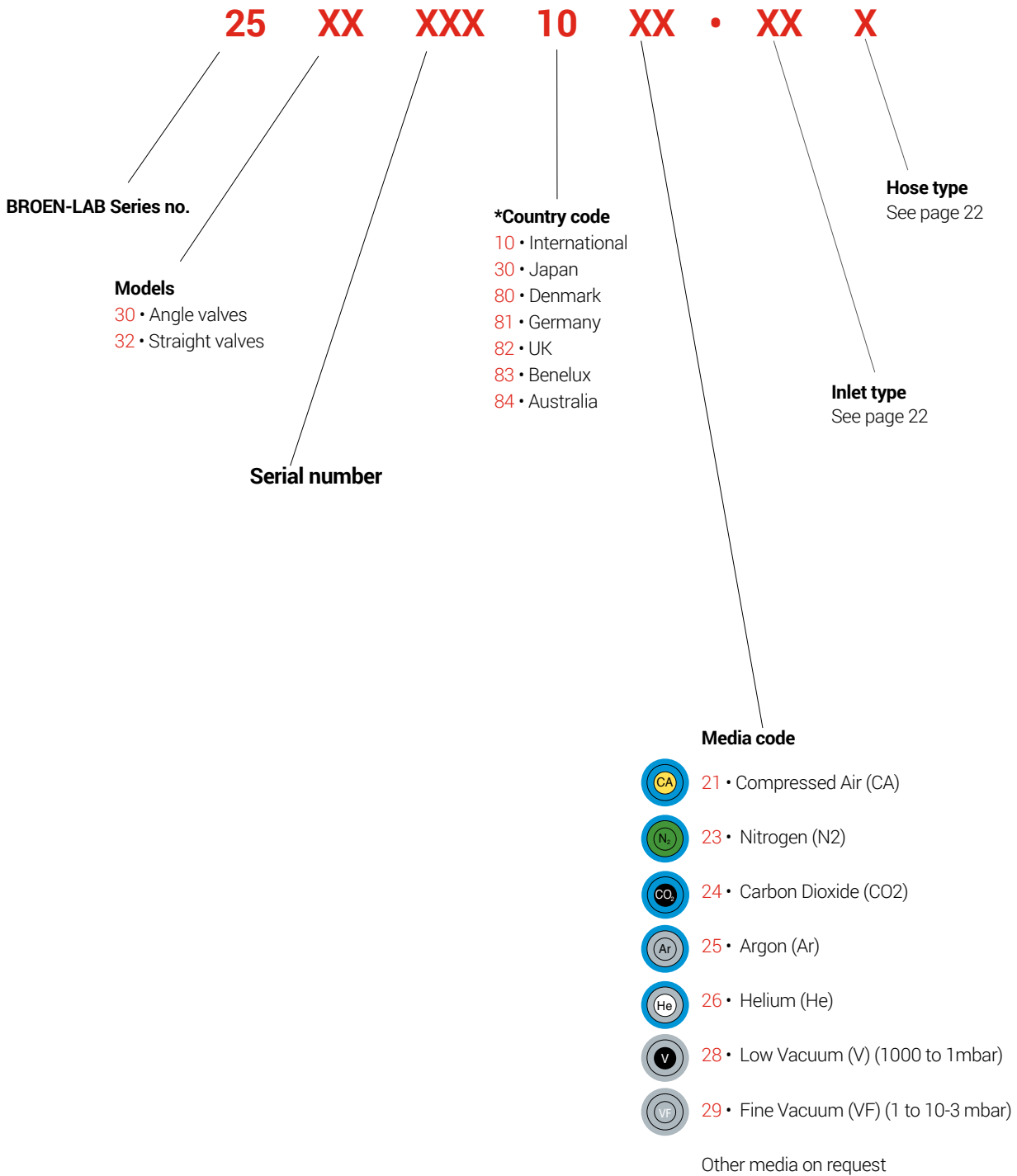

Generally, item number for BROEN-LAB UniFlex™ fittings has the following structure:

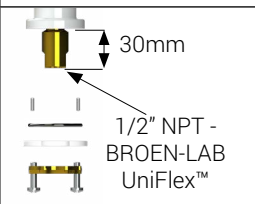
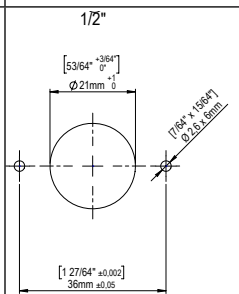
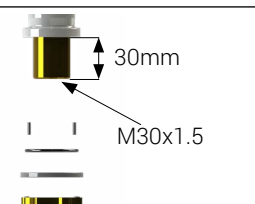
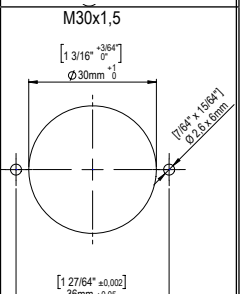
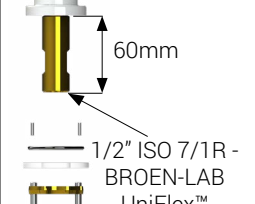
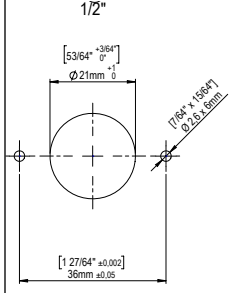
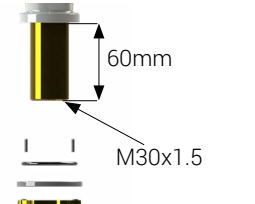
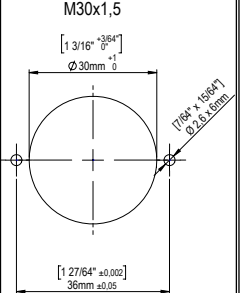
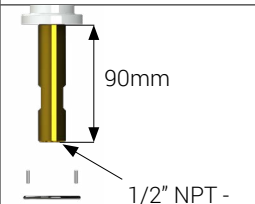
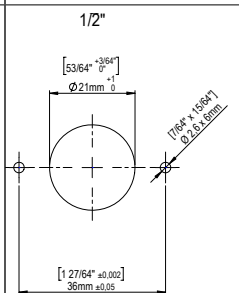
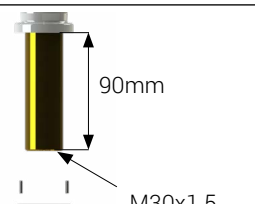
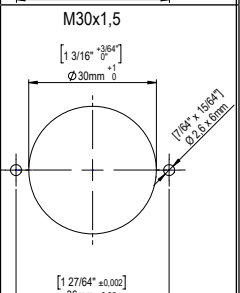

For other configuration options please contact your local BROEN-LAB representative.

ORDERING INFORMATION

Number	Inlet design	Drilling template	Number	Inlet design	Drilling template
-05	 <p>30mm 1/2" NPT - BROEN-LAB UniFlex™</p>	 <p>1/2" [53/64⁺ 3/64⁻] 0⁺ 1⁻ Ø21mm 0⁻ [1 27/64⁺ ±0.002] 36mm ±0.05 1/8" ± 1/32" ±1 Ø 2.5 x 3mm</p>	-50	 <p>30mm M30x1.5</p>	 <p>M30x1,5 [1 3/16⁺ 3/64⁻] 0⁺ 1⁻ Ø30mm 0⁻ [1 27/64⁺ ±0.002] 36mm ±0.05 1/8" ± 1/32" ±1 Ø 2.5 x 3mm</p>
-14	 <p>60mm 1/2" ISO 7/1R - BROEN-LAB UniFlex™</p>	 <p>1/2" [53/64⁺ 3/64⁻] 0⁺ 1⁻ Ø21mm 0⁻ [1 27/64⁺ ±0.002] 36mm ±0.05 1/8" ± 1/32" ±1 Ø 2.5 x 3mm</p>	-52	 <p>60mm M30x1.5</p>	 <p>M30x1,5 [1 3/16⁺ 3/64⁻] 0⁺ 1⁻ Ø30mm 0⁻ [1 27/64⁺ ±0.002] 36mm ±0.05 1/8" ± 1/32" ±1 Ø 2.5 x 3mm</p>
-18	 <p>90mm 1/2" NPT - BROEN-LAB UniFlex™</p>	 <p>1/2" [53/64⁺ 3/64⁻] 0⁺ 1⁻ Ø21mm 0⁻ [1 27/64⁺ ±0.002] 36mm ±0.05 1/8" ± 1/32" ±1 Ø 2.5 x 3mm</p>	-54	 <p>90mm M30x1.5</p>	 <p>M30x1,5 [1 3/16⁺ 3/64⁻] 0⁺ 1⁻ Ø30mm 0⁻ [1 27/64⁺ ±0.002] 36mm ±0.05 1/8" ± 1/32" ±1 Ø 2.5 x 3mm</p>

 <p>Standard length 700mm</p>	 <p>Standard length 310mm</p>	 <p>Standard length 700mm</p>	 <p>Standard length 700mm</p>	 <p>Standard length 700mm</p>
No pipe/hose No code	OD 10 mm Code "B"	CU-pipes Code "C"	G3/8" Union nut Code "D"	G 1/2" Union nut Code "E"
				OD 15 mm Code "H"

For installation with Cu- and Stainless Steel BROEN-LAB offers a wide range of connection fittings and adapters for pipes of different dimensions.

Please request document No. 99G0004 for a complete range of BROEN-LAB UniFlex™ compression ring fittings.

NOTES

HEADQUARTER

BROEN-LAB A/S

Drejervaenget 2
5610 Assens
Denmark

Tel. +45 6376 6376

lab@broen-lab.com
broen-lab.com

INTERNATIONAL OFFICES

BROEN-LAB Ltd.

Tel. +44 121 522 4515

lab@broen-lab.com
broen-lab.com

BROEN-LAB Singapore Pte. Ltd.

25 International Business Park
#04-60A German Centre
Singapore 609916

Tel. +65 6298 0662

lab@broen-lab.com
broen-lab.com

BROEN-LAB GmbH

Tel. +45 6376 6376

lab@broen-lab.com
broen-lab.com

BROEN-LAB Sverige AB

Tel. +45 6376 6376

lab@broen-lab.com
broen-lab.com

BROEN-LAB Inc.

15 Constitution Drive
Suite 122
NH 03110
Bedford
USA

Tel. +1 603 310 5089

lab@broen-lab.com
broen-lab.com

BROEN-LAB develops, manufactures and sells Laboratory Fittings, Emergency Shower Systems and Eye Wash Systems into a broad spectrum of laboratories and industrial locations; sectors include Pharmaceutical, Food&Beverage and Academia. Our expertise and product quality ensure optimal solutions compliant to all relevant international norms setting new standards in risk mitigation in modern research and development facilities.

BROEN-LAB offers solutions that ensure the functionality, compliance, hygiene, durability and safety are of the highest priority. For more than 50 years our products have been integrated into a wide variety of workplaces, laboratories, hospitals and industrial locations, with features that are assessed and designed to be flexible, durable and compliant offering a broad range of options tailored to each location. This inherent design integrity provides confidence in the solution adopted wherever in the world these are applied.

BROEN-LAB is a collaboration partner in the design and layout of your next laboratory and it's integrated safety



BROEN-LAB A/S ISO 9001 certification

In September 1991 BROEN-LAB A/S was certified according to ISO 9001 as one of the first Danish companies. The certification was carried out by Bureau Veritas, Denmark, for our Danish site in Assens. The quality management system of BROEN-LAB A/S now complies with detailed specifications laid down by the internationally acknowledged EN ISO 9001:2015. This certification will further contribute to reputation for quality and reliability of BROEN-LAB A/S.

BROEN-LAB A/S ISO 14001:2015 certification

In December 2022 we got certified according to ISO 14001 in Environmental certification. The new certification was carried out by Bureau Veritas, Denmark, for Danish site in Assens. The Environment ISO14001 management system of BROEN-LAB A/S is included in internationally acknowledged EN ISO 9001:2015. Both certifications furthermore contribute to reputation for quality and reliability of BROEN-LAB A/S.